



FODY INTL IMP & EXP CO., LTD
睿迪国际进出口有限公司



**Specializing in Machinery, Consumption material and spare parts for
Aluminium profile Industry & Stainless steel Pipe Industry*

FOSHAN, CHINA
中国·佛山

注意事项:

- 1: 图示尺寸与实物尺寸可能略有差异, 本公司有权修改或取消上述产品, 恕不另行通知。
- 2: 有关工程项目的具体尺寸数据与厂商确认。
- 3: 由于印刷的关系, 正式产品与所示的图片有部分差异, 一切以实物为准。

盛创达
Sheng Chuang Da Advertising
策划 / 摄影 / 设计
13928650123



FODY INTL IMP & EXP CO., LTD

睿迪国际进出口有限公司



FODY INTL IMP & EXP CO.,LTD
睿迪国际进出口有限公司

FOSHAN JUNRUT TRADING CO.,LTD
佛山市南海区城军瑞商贸有限公司

Head Office Add: : NO.13B1125 ,11 FLOOR, 13B BUILDING GUANGFOZHICHENG ,LINGNAN 85 ROAD ,
DALI TOWN,NANHAI AREA,FOSHAN GD CN

Managing Director : Judy Deng

Phone/Whatsapp/Wechat: +86 134 3317 8249

Email: Judydeng@fodycn.com

地址: 广东省佛山市南海区大沥广佛智城

VIP热线: 邓小姐

电话/微信: +86 134 3317 8249

电子邮件: Judydeng@fodycn.com

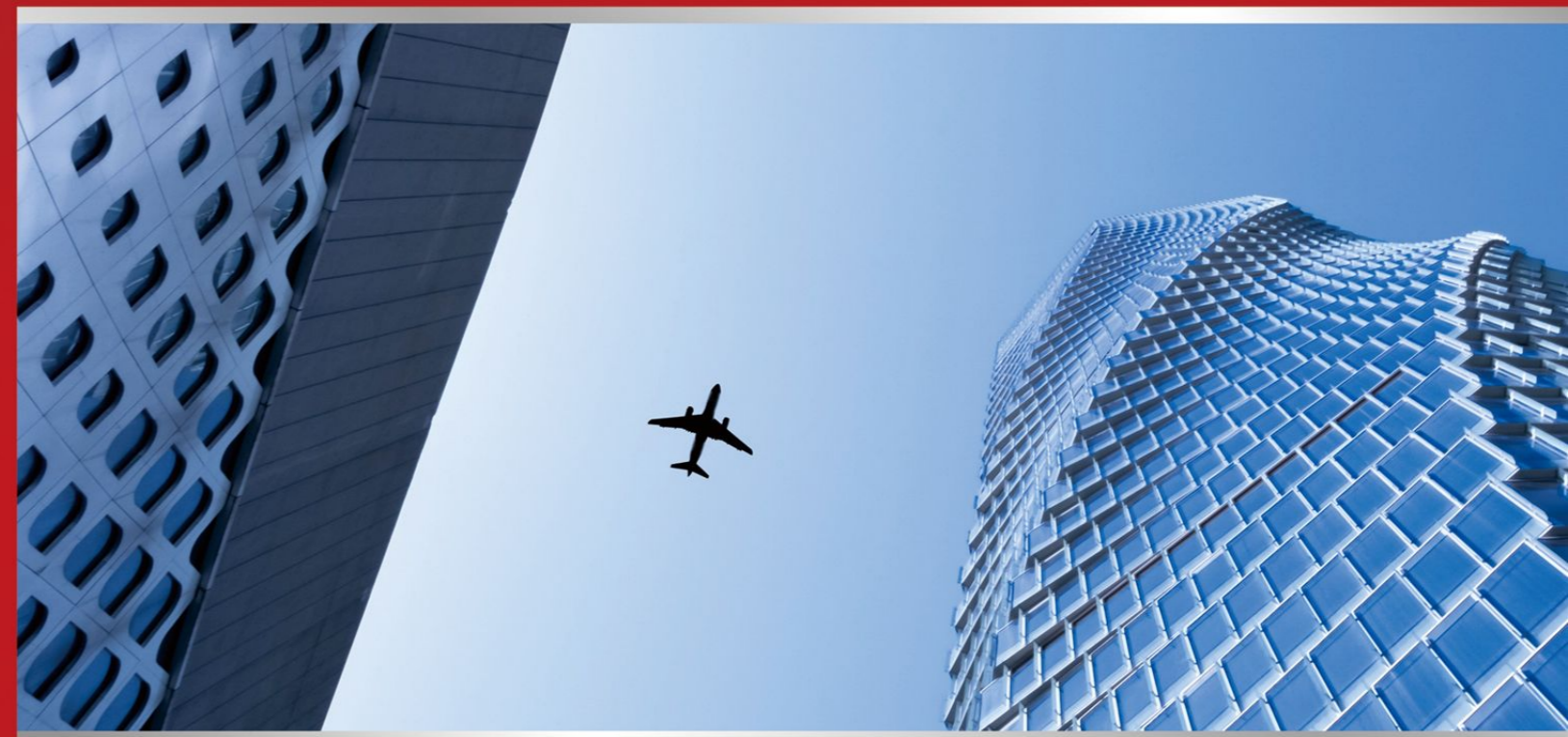

*Specializing in Machinery, Consumption material and spare parts for
Aluminium profile Industry & Stainless steel Pipe Industry

FOSHAN, CHINA
中国·佛山



COMPANY PROFILE

> 公司简介

质量为先 诚信经营

FODY INTL IMP & EXP CO., LIMITED is located in Foshan city, China, where is famous” aluminium hometown” and “stainless steel hometown”

As a comprehensive trading company, we are specialized in full line for Aluminium profile factory, from raw material ,machinery, consumption material to accessories/spare parts. As well as SS coil and Aluminium coil. We are committed to creating a one-stop purchasing service platform and providing related technical support. Offering the best cost-effective products,accurate shipment arrangement and satisfactory after service. Achieve customer economic success in efficient way is our mission.

As a result of our high quality products and outstanding service , we have gained a global sales networking reaching more than 20 countries with good comments. “quick respond, flexible handling, responsible working attitude “ is our principle. To achieve that we will keep moving. Looking forward to work with you and establish long-term cooperation relationship.



睿迪国际进出口有限公司位于素有“铝之乡”、“不锈钢之乡”之称的中国佛山市。

作为一家综合性贸易公司，我们专门为铝型材厂提供从原材料，机械，耗材到配件/备件的整体服务，以及提供不锈钢卷和铝卷。我们致力于打造一站式采购服务平台，并提供相关技术支持。提供最具性价比的产品，准确的发货安排和满意的售后服务。

我们高质量的产品和卓越的服务，已获得了全球20多个国家的销售网络，并获得了良好的评价。“快速反应，灵活处理，负责任的工作态度”是我们的原则。为了实现这一目标，我们将继续努力。期待与您合作，建立长期的合作关系。

产品目录 PRODUCT CATALOG

因为专业，所以值得信赖！

Aluminium Profile Industry 铝工业

Casting Plant 熔铸车间

- 04 Casting equipment 熔铸设备
- 05 Casting chemical 净化熔剂化工产品
- 06 ALTIB 铝钛硼丝
- 06 thermal insulation 保温和过滤产品
- 06 Nitrogen gas making machine 制氮机

Anodizing Plant 氧化车间

- 12 Aluminium conductive beam 铝大梁
- 13 Anodizing rectifier & coloring rectifier 氧化电源，着色电源
- 14 Chiller 冰机
- 14 Cooling tower 冷却塔
- 15 Pump 耐酸泵系列
- 16 PVC Board,PVC welding PVC 板，PVC 焊条
- 16 PVC pipe series PVC 管道
- 16 filter bag and re-foaming bag 消泡袋
- 16 Copper seat 铜座，铜板
- 17 Clamp 夹
- 18 Anodizing plant chemical 氧化化工

Wooden grain transfer 木纹转印膜 & 炉

- 21 Vacuum wood grain heat transfer machine 真空炉
- 22 Wooden transfer film bag series 木纹膜
- 22 Wooden transfer paper series 木纹纸，高温袋

Stainless steel pipe Industry 不锈钢管工业

- 26 SS Pipe Machinery 不锈钢管机械
- 27 Raw material 不锈钢原材料
- 28 polishing and grinding spare parts 磨砂抛光消耗品

Extrusion Plant 挤压车间

- 07 Extrusion equipment 挤压设备
- 08 Extrusion auxiliary machinery 挤压辅助设备
- 09 Felt 毛毡
- 10 Extrusion press spare parts-Line, container 料胆，挤压机配件
- 10 Cutting Saw 锯片
- 10 graphite plate 石墨板
- 10 Seal 密封圈

Powder coating 喷涂

- 19 powder coating 涂料粉末

Packing film and Packing machinery 包装材料 & 包装机械

- 23 Protective film 保护膜
- 23 Shrinking film 收缩膜
- 24 Protective film machine 保护膜机
- 24 Cutting machine 分条机
- 25 Shrinking film machine 收缩膜机
- 25 Wrapping machine 缠绕机
- 25 laser machine 激光打码机

Aluminium composite panel 铝塑复合板

- 29 Aluminium composite panel 铝制复合板
- 30 Color coated aluminium coil 铝卷
- 30 Polymeric membrane adhesive film 高分子膜
- 30 protective film for ACP 保护膜

Casting Plant

熔铸车间

Casting equipment

熔铸设备



Melting furnace 熔铸炉



Casting Mould 铸造水盘



Hot top casting mould 铝棒铸造模具

Hot top casting mould applicable to all series of aluminum casting rod.

Mainly by the cold water tank and condenser, distribution of guide, guide device, positioning device.

本铸棒模具为同水平热顶铸造结构，适用于各系列的铝合金圆棒铸造。主要由水套、结晶器、分流盘、套管、引锭头、引锭平台、对中器组成。





Casting Plant

熔铸车间

Casting chemical

净化熔剂化工品

卓越品质·服务全球 Excellent quality and global service



镁锭 Magnesium ingot



金属硅 Silicon

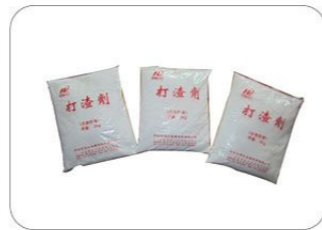

Fluxing Agent
打渣剂



Covering Agent
覆盖剂



Furnace cleaning Agent
清炉剂

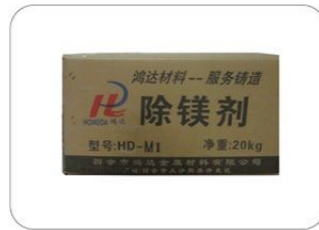

De-magnesium agent
除镁剂



Refining Agent
精炼剂

Name	Function	Package
Fluxing Agent	Excellent performance in dressing, separate aluminium alloy and dross, No odor when using, environment friendly. Be suitable for inside and outside furnace	2kg/inner plastic bag, 20kg/carton
Refining Agent	Excellent performance in degassing, Strong ability in refining of the melt.	2kg/inner plastic bag, 20kg/carton
Covering Agent	Forming a dense protective layer, reducing the involvement of the gas. Reduces the metal loss caused by oxidation of the liquid on the surface. Excellent performance in fluidity and covering effect.	2kg/inner plastic bag, 20kg/carton
Furnace cleaning Agent	Furnace cleaning Agent is a strongly exothermic product, with its strong exothermic and stripping action, the residues on the walls are loosening and can be removed easily by scraping tools.	2kg/inner plastic bag, 20kg/carton
De-magnesium agent	White powder, excellent performance in remove excess magnesium from melting aluminum alloy.	2kg/inner plastic bag, 20kg/carton

Casting Plant

熔铸车间

ALTIB

铝钛硼丝

AlTi5B1 rod diameter is 9.5mm, diameter tolerance is ± 0.3 mm, for aluminum alloy 6063, includes Ti 4.5~5.5%, Si is less than 0.2, Fe is less than 0.3, V is less than 0.2, B is 0.4~1.2, others is less than 0.1, all balance is aluminum.

- AlTi5B1 棒材直径为 9.5mm, 直径公差为 ± 0.3 mm, 用于 6063 铝合金, 包括 Ti 4.5~5.5%, Si 小于 0.2, Fe 小于 0.3, V 小于 0.2, B 为 0.4~1.2, 其他小于 0.1, 全部平衡为铝。



Nitrogen gas making machine

制氮机

N2 function: In the aluminum melting process, N2 is the protective gas, which is used to drive away the oxygen to prevent aluminum from being oxidized, ensure that after melting can get more pure aluminum.

- N2 作用: 在铝的熔炼过程中, N2 是保护气体, 用来驱走氧气, 防止铝被氧化, 保证熔炼后能得到更纯的铝。

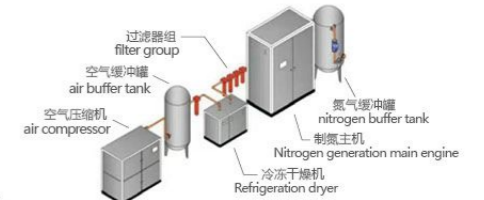

Thermal insulation

保温和过滤产品

Ceramic Foam Filter

陶瓷过滤板



Fiber Cone 塞头

Fiber cone is used for control or block the flow of the liquid aluminum for the precision casting of aluminium and aluminum alloy.

纤维锥用于控制或阻断铝液的流动, 用于铝及铝合金的精密铸造。



Standard size 标准尺寸:
 $\phi 65 \times 65$ mm, $\phi 70 \times 100$ mm, $\phi 90 \times 130$ mm

refractory brick 保温砖





Extrusion Plant

挤压车间

Extrusion equipment

挤压设备

Extrusion Press machine 挤压机

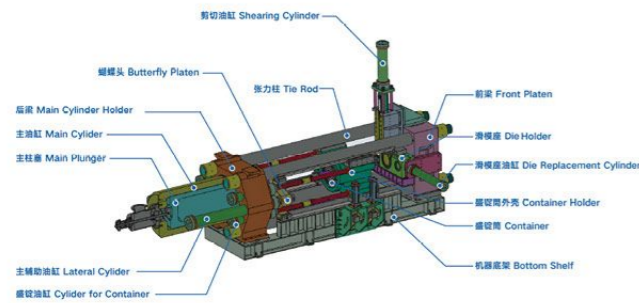

Model	Usage Pressure	Plunger size	Main Cylinder size	Billet Size	Center Height	Profile Exit size	Total power kw	Overall Size mm	Total Weightt T
	Mpa	mm	mm	mm	mm	mm			
500T(550UST)	21	∅ 520	∅125 x ∅70	∅76×380	850	∅110	72	5700×3100×2500	20
600T(660UST)	21	∅ 580	∅160 x ∅120	∅90×480	850	∅110	105	6000×3200×2600	24
700T(770UST)	21	∅ 620	∅160 x ∅120	∅102×520	1030	∅120×140	130	7900×2800×3500	38
800T(880UST)	21	∅ 660	∅180 x ∅140	∅114×530	1050	∅130×150	132	8500×3015×3560	42
1000T(1100UST)	21	∅ 750	∅200 x ∅150	∅127×650	1095	∅140×160	195	9660×3070×3900	53
1250T(1400UST)	21	∅ 840	∅200 x ∅150	∅140×650	1180	∅170×200	250	11920×3230×3900	65
1400T(1540UST)	21	∅ 870	∅220 x ∅150	∅152×680	1180	∅180×210	260	11920×3230×3900	70
1650T(1800UST)	21	∅ 950	∅220 x ∅150	∅178×800	1530	∅210×260	315	13400×3580×4900	90
2000T(2200UST)	21	∅ 1050	∅125 x ∅180	∅203×800	1680	∅240×300	350	16500×4000×5100	136
2500T(2750UST)	21	∅ 1180	∅250 x ∅180	∅229×1000	2030	∅280×350	550	17500×6000×6500	250
3000T(3300UST)	28	∅ 1180	∅250 x ∅180	∅254×1000	2030	∅338×480	780	17500×6000×6500	300
4350T(4785UST)	28	∅ 1350	∅320 x ∅220	∅279×1000	2280	∅450×500	960	19500×6900×7500	350
5500T(6000UST)	28	∅ 1500	∅380 x ∅250	∅406×1000	2350	∅490×620	1660	22000×8000×10000	650
8200T(9000UST)	28	∅ 1780	∅480 x ∅320	∅483×1000	2585	∅550×800	2500	28000×9800×11000	800

Extrusion Plant

挤压车间

Extrusion auxiliary machinery

挤压辅助设备

Aging Furnace 时效炉



Aluminium profile must be put into the aging furnace for aging treatment after extrusion.

- 当铝合金型材被挤压出来后，经过校直，定尺切断后，就必须装入时效炉进行时效处理。

Billet heating furnace 棒炉

Billet heating furnace is used to preheat billets before extrusion. We have four types of heating furnaces: short billet heating furnace, single billet heating furnace with hot log shear, multi billet heating furnace with hot log shear, infrared type billet heating furnace with hot log shear.

- 棒炉用在挤压前的预热。我司拥有四种加热炉：短棒加热炉、短棒单支热剪加热炉，多棒热剪加热炉，红外线棒炉。



Puller and Run Out table 牵引机和冷床

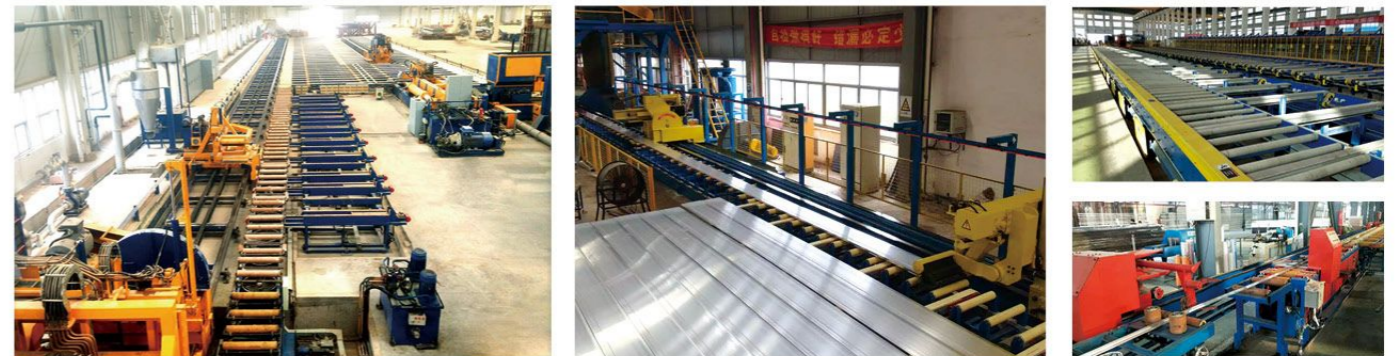



Extrusion Plant

挤压车间

Felt

毛毡

Heat-resistant felt for aluminium extrusions including seamless conveyor belt, felt roller, felt pad, space sleeve, timing belt with felt.

- 铝型材耐热毛毡包括无缝输送带、毛毡辊、毛毡垫、间隔套、带毛毡同步带。

Working temperature 工作温度:
600°C, 500°C, 280°C, 180°C

耐高温毛毡应用示意图

Schematic diagram of application of high temperature resistant felt

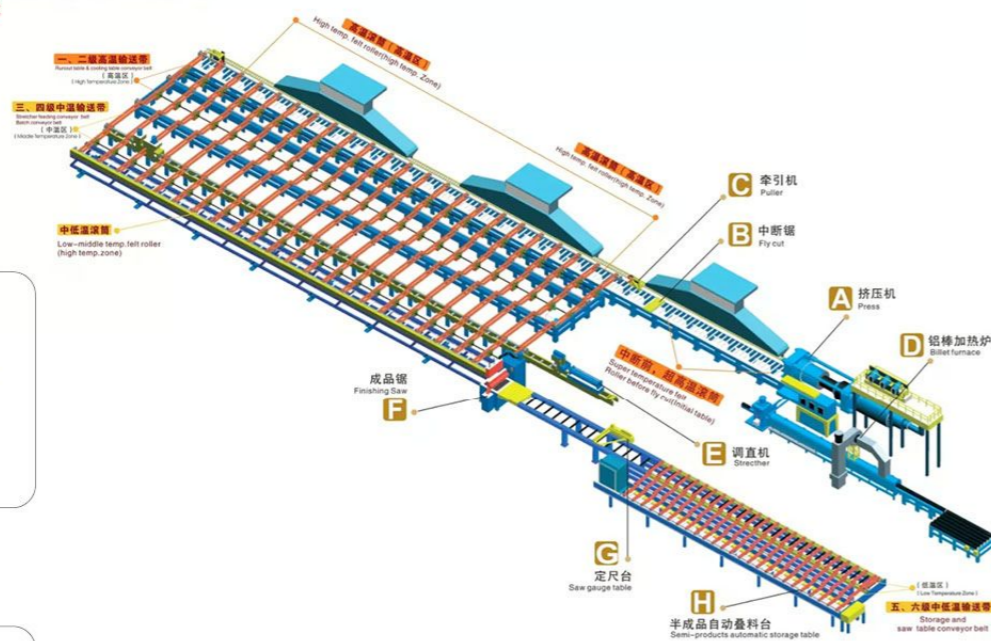

Felt Pad 毛毡条



Felt Roller 滚筒



Seamless Coveyor Belt 输送带



Spacer Sleeve 毛毡套

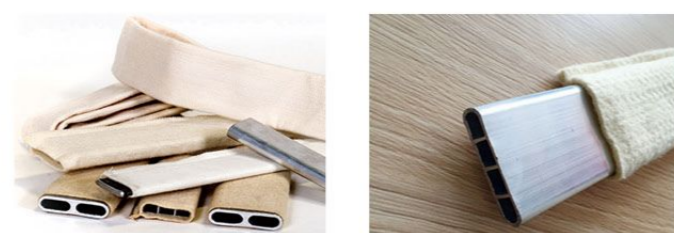

Extrusion Plant

挤压车间

Extrusion press spare parts-Liner, container

料胆 / 挤压机配件

Extrusion machinery spare parts series :

挤压机配件系列

We can supply all spare parts of extrusion machinery with competitive price, for example: liner, container, Shear Blade, shim, moving block, stem, cylinder, ect. Just provide us the drawing.

- 我们可以提供料胆，内胆，挤压杆，剪刀，挤压饼等挤压机配件。

aluminium extrusion press container 铝挤压机容器

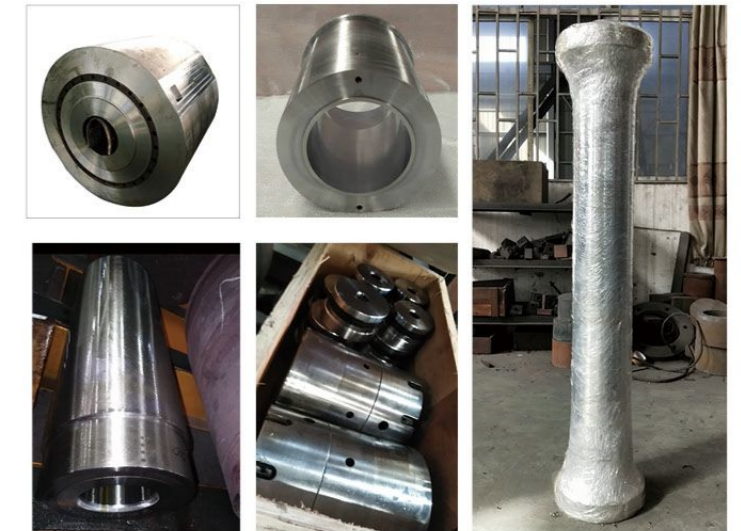

Cutting Saw

锯片

aluminium profile cutting saw 铝型材切割锯

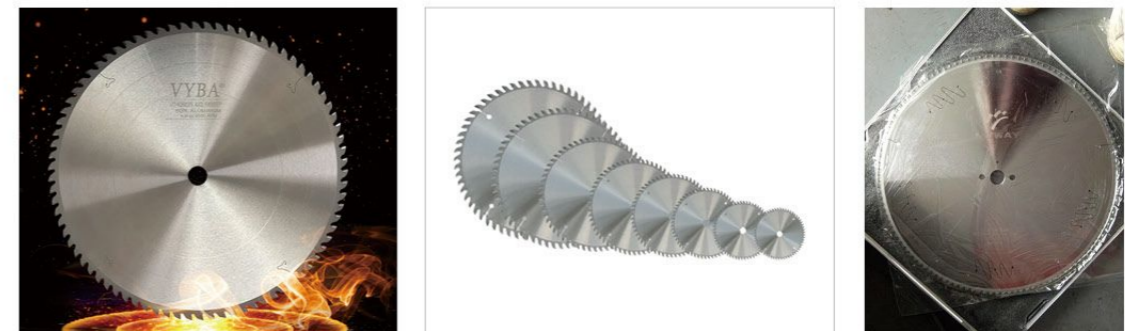

graphite plate

石墨板

graphite plate 石墨板

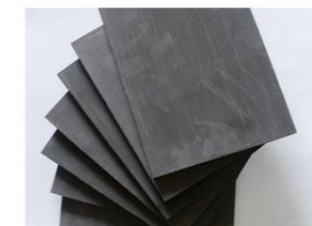

Seal

密封圈

Seal 密封圈





tank 氧化槽



Oxidation workshop 氧化车间



Oxidation workshop 氧化车间



Anodizing plant 阳极氧化装置

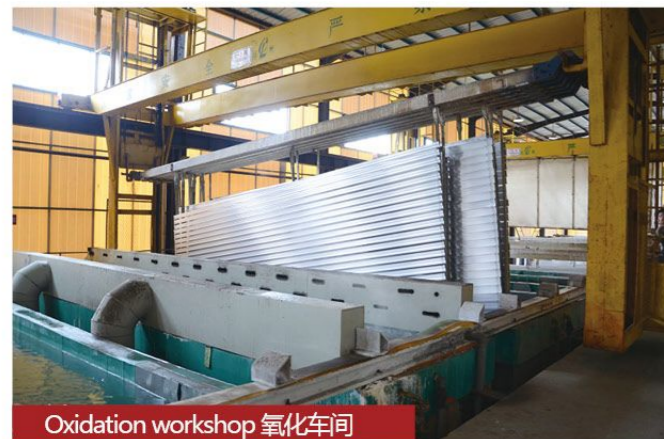

Oxidation workshop 氧化车间



Oxidation workshop accessories flow 氧化车间配件流程图

Aluminium conductive beam

铝大梁

Electric Conductive beam drawing

导电束绘图

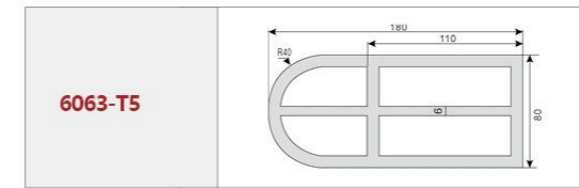

6063-T5

Electric Conductive beam

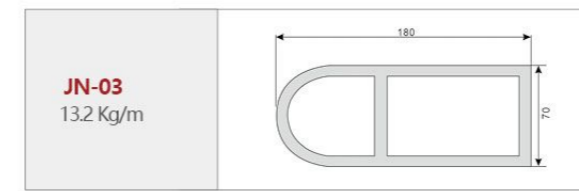

JN-03
13.2 Kg/m

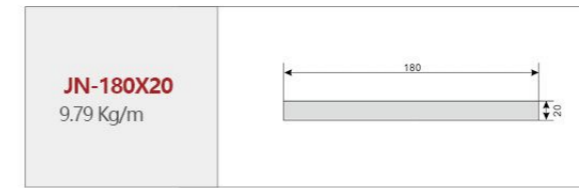

JN-180X20
9.79 Kg/m

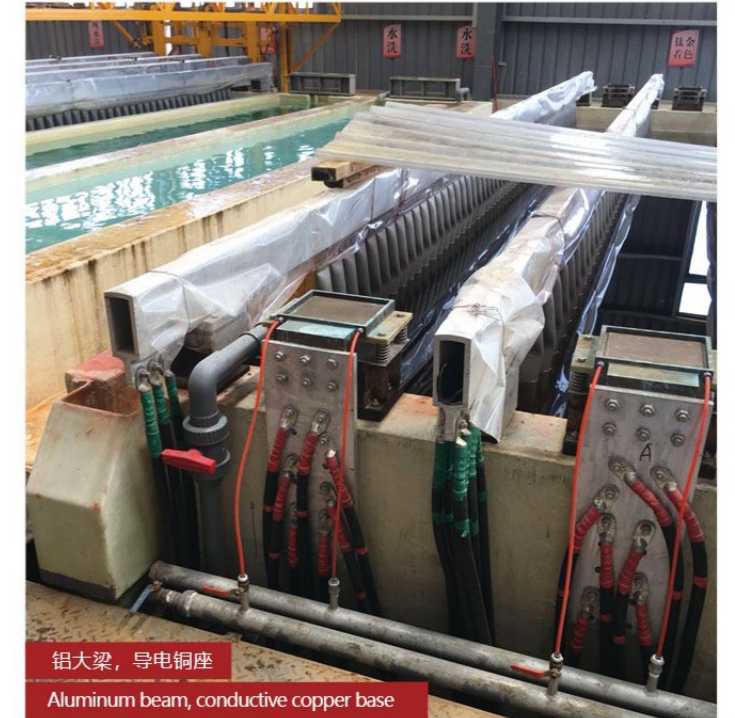

铝大梁, 导电铜座
Aluminum beam, conductive copper base



Aluminium conductive beam
导电铝梁



Cover plate size: 100mm*150mm*3mm
Cover plate will be used two pcs for each side of beam



Anodizing rectifier & coloring rectifier

氧化电源, 着色电源



Silicon control Anodizing rectifier

可控硅阳极氧化整流器

Technical Specification:

技术规范:

1. Input frequency: 3 Phase AC 380V+10%(can custom-made), 50Hz
 2. Dc Output voltage: 8~60v(can custom-made)
 3. DC Output current: 1000-30000A
 4. Output adjustable range: 5%~100% continuously adjust
 5. Cooling system: Air cooling/water cooling
- 1. 输入, 频率: 3 相交流 380V+10%(可定制), 50Hz
 - 2. 输出电压: 8~60v(可定做)
 - 3. 直流输出电流: 1000 - 30000
 - 4. 输出可调范围: 5%~100% 连续调节
 - 5. 冷却系统: 风冷 / 水冷



Double wave coloring rectifier

双波着色整流器

Technical Specification:

技术规范:

1. AC powder input, frequency: 3 Phase AC 380V+10% (can custom-made), 50Hz
 2. Voltage rate: 25V
 3. Output current: 1000-20000A (according to custom requirement)
 4. Output wave: full DC wave, AC wave
 5. Cooling system: Air cooling /Water cooling
- 1. 交流粉末输入, 频率: 3 相交流 380V+10%(可定制), 50 赫兹
 - 2. 电压率: 25 v
 - 3. 输出电流: 1000-20000A(根据客户要求)
 - 4. 输出波: 直流全波、交流全波
 - 5. 冷却系统: 风冷 / 水冷

Chiller

冰机



chiller 冷水机组



Cooling tower

冷却塔



plate heat exchanger

板式换热器

Plate heat exchanger is a new type of high efficiency heat exchanger which is made of a series of corrugated metal sheets.

A thin rectangular channel is formed between the plates, through which the heat exchange between liquid, liquid and vapor can be achieved.

- 板式换热器是由一系列波纹金属板制成的一种新型高效换热器。在板之间形成一个薄的矩形通道, 通过它可以实现液体、液体和蒸汽之间的热交换。



plate heat exchanger 板式换热



Seal ring for plate heat exchanger
板式换热器密封圈



Anodizing Plant

氧化车间

Pump series

▶ 耐酸泵系列

Centrifugal circulated water pump

离心循环水泵

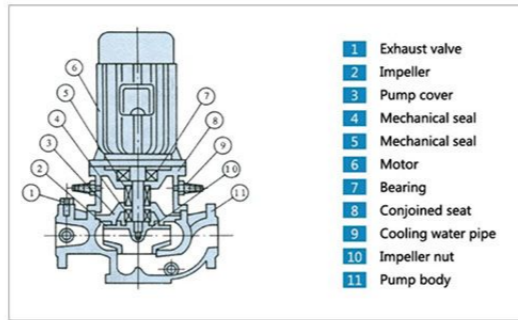

IHF Fluorine centrifugal chemical acid pump

氟离心化学酸泵



SS waste water disposal pump

SS 废水处理泵



Anodizing Plant

氧化车间

PVC Board, PVC welding

▶ PVC 板 / PVC 焊条

PVC soft Board (PVC 软板)



Thickness: >=20mm
Width: 1000mm
Size per roll: 9800mm*1200mm
Consumption: For anodizing tank, usually the thickness is 4mm, 6.5kgs/one square meter
Color: Green, grey, white, brown and custom-made

厚度: >= 20 毫米
宽度: 1000 毫米
每卷大小: 9800 毫米 * 1200 毫米
消耗: 用于阳极氧化槽, 通常厚度为 4mm, 6.5kgs/ 1 平方米
颜色: 绿色, 灰色, 白色, 棕色和定制

PVC Welding Rod (Soft) PVC 焊条



PVC Welding Rod (Hard) PVC 焊条 (硬)



PVC welding gun PVC 焊枪



PVC pipe series

▶ PVC 管道



filter bag and re-foaming bag

▶ 消泡袋



Copper seat

▶ 铜座 / 铜板





Anodizing Plant

氧化车间

▶ Clamp 夹

Anodizing clamp 氧化系列



Anodizing clamp 阳极氧化夹:
Range of application:
 Anodizing manual clamp for aluminum profile up and down, easy to operate
Temperature resistance: 200 °C

应用范围:
 铝型材上下阳极氧化手动夹紧, 操作方便
耐温: 200°C

Electrophoretic& Anodizing acid clamp 电泳强酸电泳



Electrophoretic/Anodizing acid clamp 电泳 / 阳极氧化酸夹:
Range of application:
 Electrophoretic/Anodizing strong acid manual clamp for aluminum profile up and down, easy to operate
Temperature resistance: 280 °C

应用范围:
 电泳强酸手动夹具 用于铝材上下排, 操作方便快捷
耐温: 电泳系列 (耐高温 280 °C)。
 如需耐三酸, 需另外定制。

G clamp G 型夹



G clamp G 型夹:
Range of application:
 Suitable for anodizing production line (if electrophoresis is required, additional customization is required)

应用范围:
 适用于阳极氧化生产线 (如果需要电泳, 需要额外定制)

Powder coating Clamp 喷涂系列



Powder coating Clamp 喷涂系列:
Range of application:
 For powder coating production line, 316L ss material, there are several stypes for your choose. New style with pawl construction, no need to punch, improve work efficiency

应用范围:
 对于粉末涂料生产线, 316L 材料, 有多种型号供您选择。
 新型爪式结构, 无需打孔, 提高工作效率

Pneumatic Clamp 气动夹



Pneumatic Clamp 气动夹:
Range of application:
 The semi-automatic production line which is suitable for aluminium profile up and down, improve work efficiency, increased economic income.

应用范围:
 用于铝材上下排, 能适用于流水线的半自动化生产, 有效地降低工人的劳动强度。
产品说明: 气动夹具有节能环保、操作简便、省力高效的特性, 配套气动开夹器使用, 女工上下排也很轻松, 从而节省了成本, 增加了经济效益。

Anodizing Plant

氧化车间

Anodizing plant chemical

▶ 氧化化工



classification 分类

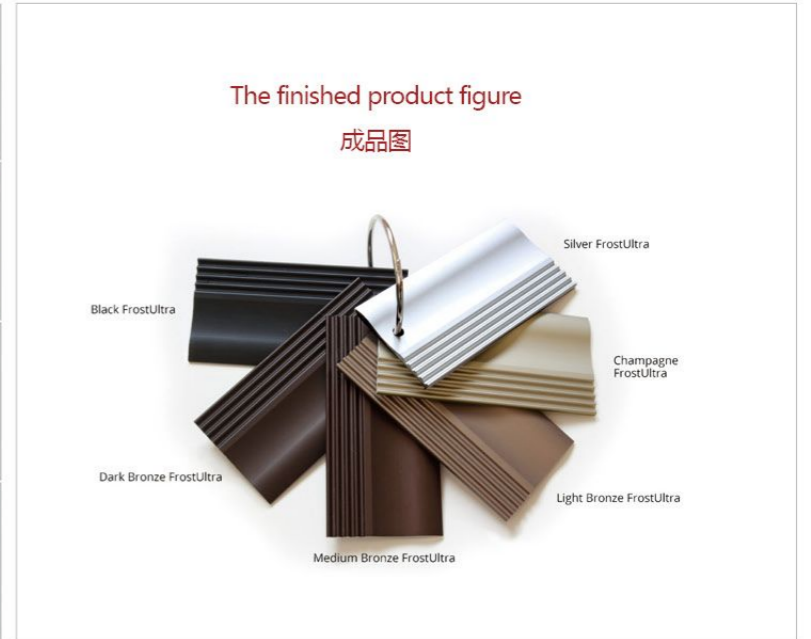

The finished product figure
 成品图

Anodizing surface treatment processing flow-sheet

氧化车间流程



Powder costing surface treatment processing flow-sheet

喷涂车间流程



Wooden grain transfer surface treatment processing flow-sheet

木纹流程

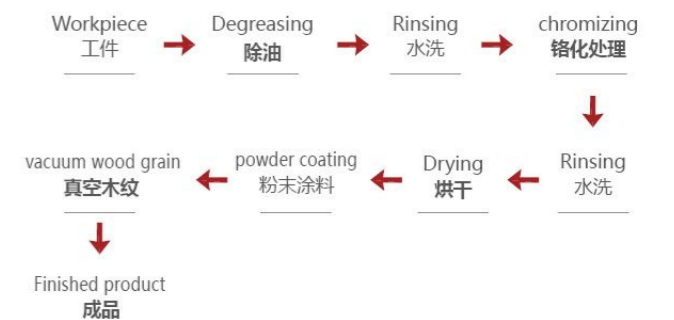



Powder coating

喷涂车间

Powder coating

▶ 涂料粉末



Powder coating chemical
粉末涂料的化学



Neon powder coating powder 500x500
霓虹灯粉末涂料粉末 500x500



Finished product drawing
产品成品图



Finished product drawing
产品成品图



powder coating line 喷涂生产线

Wooden grain transfer

木纹转印膜 & 炉

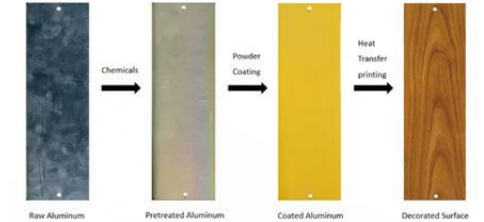

The wood grain aluminum profile has both advantages of aluminum profile and wood and it is bright spot for the decoration in the world, it's more and more popular in the future market

So how to make wood grain effect aluminum profile?

木纹铝型材兼有铝型材和木材的优点，是世界上装饰的亮点，在未来的市场上越来越受欢迎
那么如何制作木纹效果铝型材呢？

1. Preparation:

Aluminum profile, vacuum wood grain heat transfer machine, the wood grain paper or film bag.

2. Condition :

Aluminum profile must be powder coated or electrophoresis treatment, and then we can start wood grain transfer printing.

3. Process flow as follows:

Aluminum profile in powder coated or electrophoresis treatment → cover aluminum profile with wood grain paper or PET hot transfer printing film → 170-200 °C baking → remove the film → wood grain aluminum profile finished → packaging.

4. Wooden grain aluminium profile advantage:

Aluminium extrusion profile surface is fine and smooth;
With high coating strength and powerful adhesion strength;
With acid resistance, weather resistance, decay resistance, alkali resistance and shock resistance;
Wood grain aluminum profile decoration effect can be better than solid wood

1. 准备：

铝型材、真空木纹热转印机、木纹纸或膜袋。

2. 条件：

铝型材必须进行粉末涂布或电泳处理，然后才能开始木纹转印。

3. 工艺流程如下：

铝型材涂粉或电泳处理→用木纹纸或 PET 热转印覆盖铝型材印刷薄膜→ 170-200°C烘烤→揭膜→木纹铝型材成品→包装。

4. 木纹铝型材优点：

铝挤压型材表面细腻光滑；涂层强度高，附着力强；
具有耐酸、耐候性、耐腐蚀性、耐碱性和耐冲击性；木纹铝型材装饰效果可优于实木。



Vacuum wood grain heat transfer machine:

▶ 真空炉:

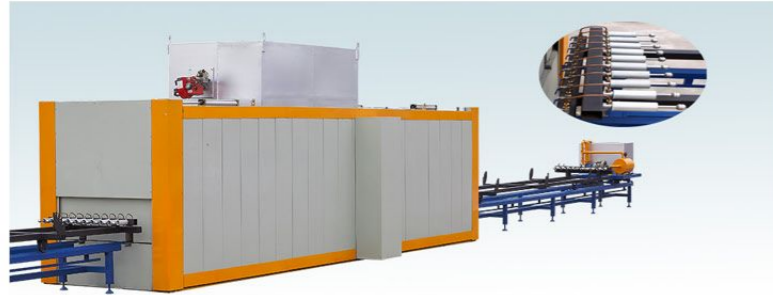

The vacuum wood grain aluminum profile machine can transfer the pattern of wood grain paper to the surface of aluminum extrusion by heating, and get the clear grains and have third dimensional feeling, make the wood grain aluminum looks like more natural.

真空木纹铝型材机通过加热将木纹纸的花纹转移到铝材挤压表面,得到的纹路清晰,有立体感,使木纹铝材看起来更自然。

For material ,there are two options, one is wooden transfer film bag series, the other is wooden transfer paper series .

材料有两种选择,一种是木转印膜袋系列,另一种是木转印纸系列。



Wooden transfer film bag series

▶ 木纹膜

Material: Woonden transfer film bag, Textured Paper

Consumption:

1MT aluminium profile Consumption ≈ 600~650 square meter .

材料: 木质转印膜袋, 纹理纸

1MT 铝型材耗材≈ 600~650 平方米。



Wooden transfer paper series

▶ 木纹纸, 高温袋

Material: Woonden transfer papaer,high temperature Bag, High temperature sticker

Consumption:

1MT aluminium profile Consumption ≈ 500Meter wooden transfer paper, 1MT aluminium profile Consumption ≈ 30~40kgs high temperature bag .

材料: 木质转印纸、高温袋、高温贴纸

1MT 铝型材消耗≈ 500m 木转印纸, 1MT 铝型材消耗≈ 30~40kgs 高温袋。

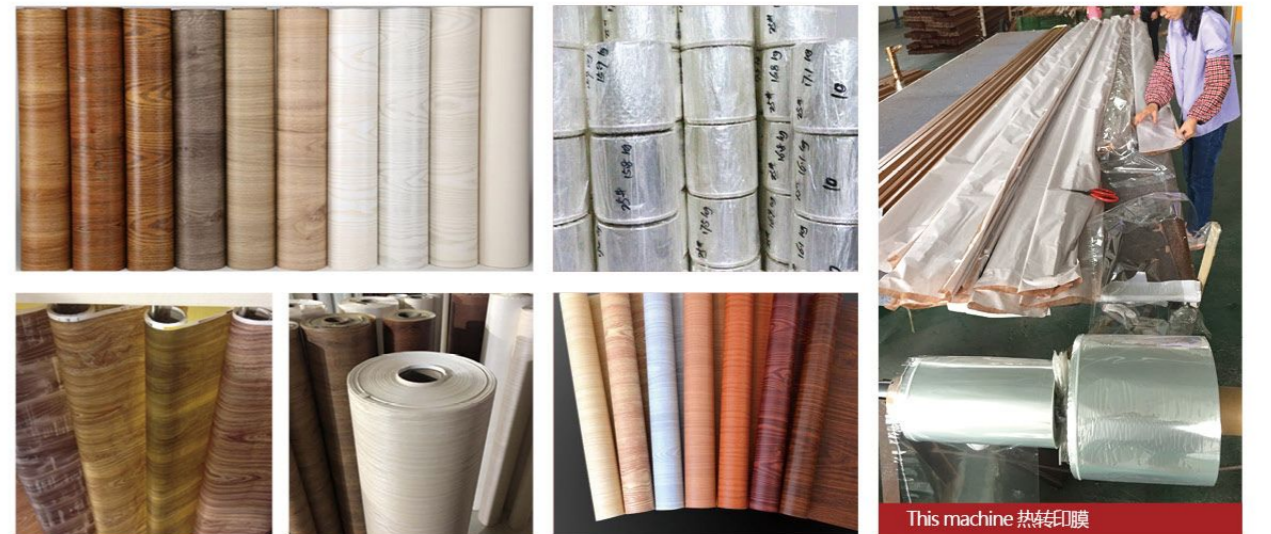

This machine 热转印膜

PE protective film for aluminium profile

保护膜

PE protective film protected the product in the production process, transportation, storage and use of the process without pollution, corrosion, scratch, protect the original bright and shiny surface, thereby improving the quality of products and market competitiveness.

PE 保护膜保护了产品在生产过程中, 运输、储存和使用过程中不受污染、腐蚀、划伤, 保护了表面原有的光亮和光泽, 从而提高了产品质量和市场竞争能力。



Shrinking film

收缩膜

PVC, PE SHRINK FILM (PVC、PE 收缩薄膜)

Product description 产品描述

PVC/PE Shrink film is made of numerous vinyl monomers polymerized into polyvinyl chloride and formed through some special processes such as mold forming and molded bubble flowing inflation etc, after multi-layer coextrusion.

1. PVC shrink film has such features as high transparency, good gloss, and high shrinkage, etc.
2. PE shrink film has such advantages as good flexibility, impact resistance; tear resistance, not liable to damage; moisture resistance, protectiveness, compressibility, and saving costs etc.

PVC/PE 收缩膜是由多种乙烯基单体聚合而成, 经过模具成型、模泡流动膨胀等特殊工艺, 经多层共挤而成。

1. PVC 收缩膜具有透明度高、光泽度好、收缩率高等特点。
2. PE 收缩膜具有柔韧性好、抗冲击等优点; 耐撕, 不易损坏; 防潮、保护、压缩、节约成本等。



pet heat shrinkable film
Pet 热收缩膜



shrink film 500x500
收缩薄膜 500 x500



TUBING-RR

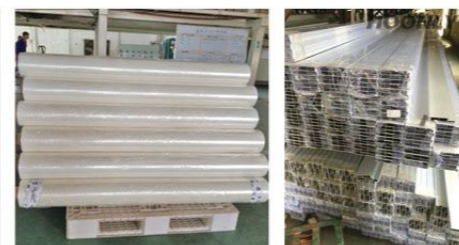

Shrink Protective Film PVC Film PE Film
for Aluminium Extrusion Profile
收缩保护膜 PVC 膜 PE 膜铝型材挤压机

Protective film machine

保护膜包装机



- ① . Overall dimension (L × w × h mm): 1880 × 680 × 1500 mm
- ② . applicable power supply: single-phase 220V AC 50Hz; motor power: 0.75KW
- ③ . roller size: φ100 × 250mm; imported polyurethane
- ④ . film feeding speed: 0-280 M / min
- ⑤ . Film range: top, bottom, left, right and four sides (imported "Shilin" frequency converter)
- ⑥ . specification of the maximum pasteable profile: 250mm wide × 150mm high.

Main purpose performance:

This machine is suitable for the packing of protective film on the surface of stainless steel profile, plastic steel profile, aluminum alloy profile, etc. The surface of profile can be better protected and more competitive in the market.

working principle:

The machine adopts frequency conversion to adjust the motor to control the film speed of the profile, and adjusts the four sides of the material of each pressing roller pair to apply the film. Note: This equipment is provided with 2.4.5m conveying supports.

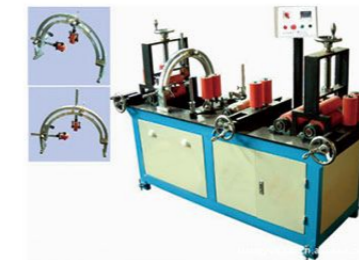

Cutting machine

保护膜分切机

Specifications 规格:

- ① . external dimension (L × w × h mm): 2500 × 1150 × 1200 mm
- ② . applicable power supply: single-phase 380V / AC 50Hz; motor power: 2.2kW;
- ③ . cutting film φ 250mm. With two blades.
- ④ . The inner diameter of the paper core is φ 76mm.
- ⑤ . the processing dimension is 1600mm long.
- ⑥ . Net weight: 540kg

- ① . 外型尺寸 (长 × 宽 × 高mm): 2500×1150×1200 mm
- ② . 适用电源: 单相 380V/AC 50HZ; 电机功率: 2.2KW;
- ③ . 分切膜 φ250mm。配两把刀片。
- ④ . 纸心内径 φ76mm。
- ⑤ . 加工尺寸长 1600mm。
- ⑥ . 净重: 540kg



Shrinking film machine

收缩膜机



此设备可根据客户型材大小订做，详情请来电洽谈。

1. One "universal" high-speed temperature resistant wind turbine (3450rpm, 140 °C) is installed above the heat box.
2. Adopt side plug U-shaped metal far infrared heating tube, 380V three-phase four wire power supply, power 12KW.
3. The imported AC contactor and the domestic famous temperature control meter form an automatic temperature control circuit with a maximum temperature of 200 °C .
4. Stepless "handle" speed regulating motor, conveying speed 0-30m / min (adjustable), conveying weight 80kg.
5. The machine features superior performance, fast packaging speed, no film breakage, low temperature energy saving and shrink packaging.

laser machine

激光打码机

Laser marking machine with 20W,30W and 50W type , is used for printing company logo, production data and any other information on aluminium, copper, stainless steel ect..

激光打标机分 20W、30W、50W 三种类型，用于打印铝、铜、不锈钢等材料的公司标志、生产资料等信息。



Wrapping machine

缠绕机



Description 描述:

The machine can be used to pack the following profiles: extrusion aluminum profile, plastic-extrusion profile, plastic-steel profile, stainless steel profile and other materials which need surface-protecting treatment.

本机适用于以下型材的包装：挤压铝型材、塑料挤压型材、塑钢型材、不锈钢型材及其他需要表面保护处理的材料。

SS Tube Making Machine

SS 制管机

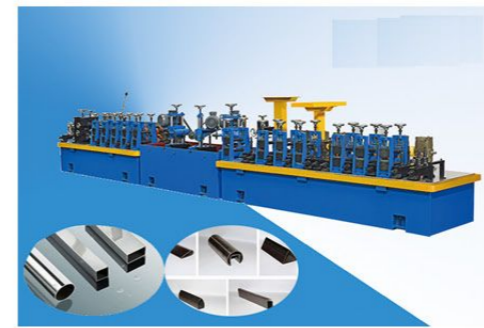

Pipe polishing machine

管抛光机



SS coil slitting machine

SS 卷切机

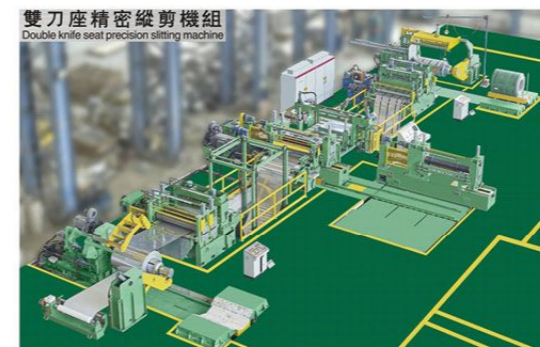

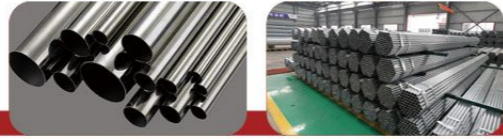

Stainless steel pipe » 不锈钢管

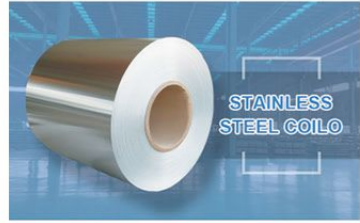

Raw material

▶ 原材料

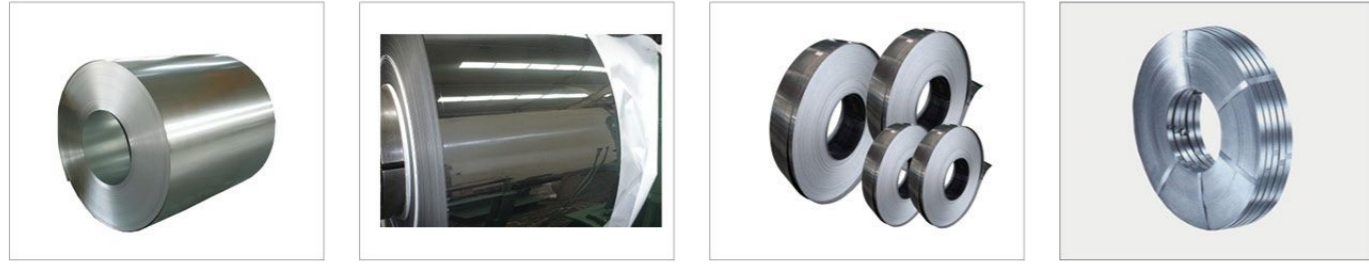

Material	201/201/203/304/304L/309/309/309s/310/310S/316/316L/410/430,ect
Standard	ASTM,GB,JIS,ect
Thickness	0.15-100mm
Width	600-2500mm
Length	1000-6000mm or as customer's requirement
Surface finished	2B/BA/HAIRLINE/8KNO.4
Technique	Cold rolled/hot rolled
Coil weight	3.5-5tons for normal standard or as your requirement



Stainless steel pipe » 不锈钢管

Polishing and grinding spare parts

▶ 磨砂抛光消耗品

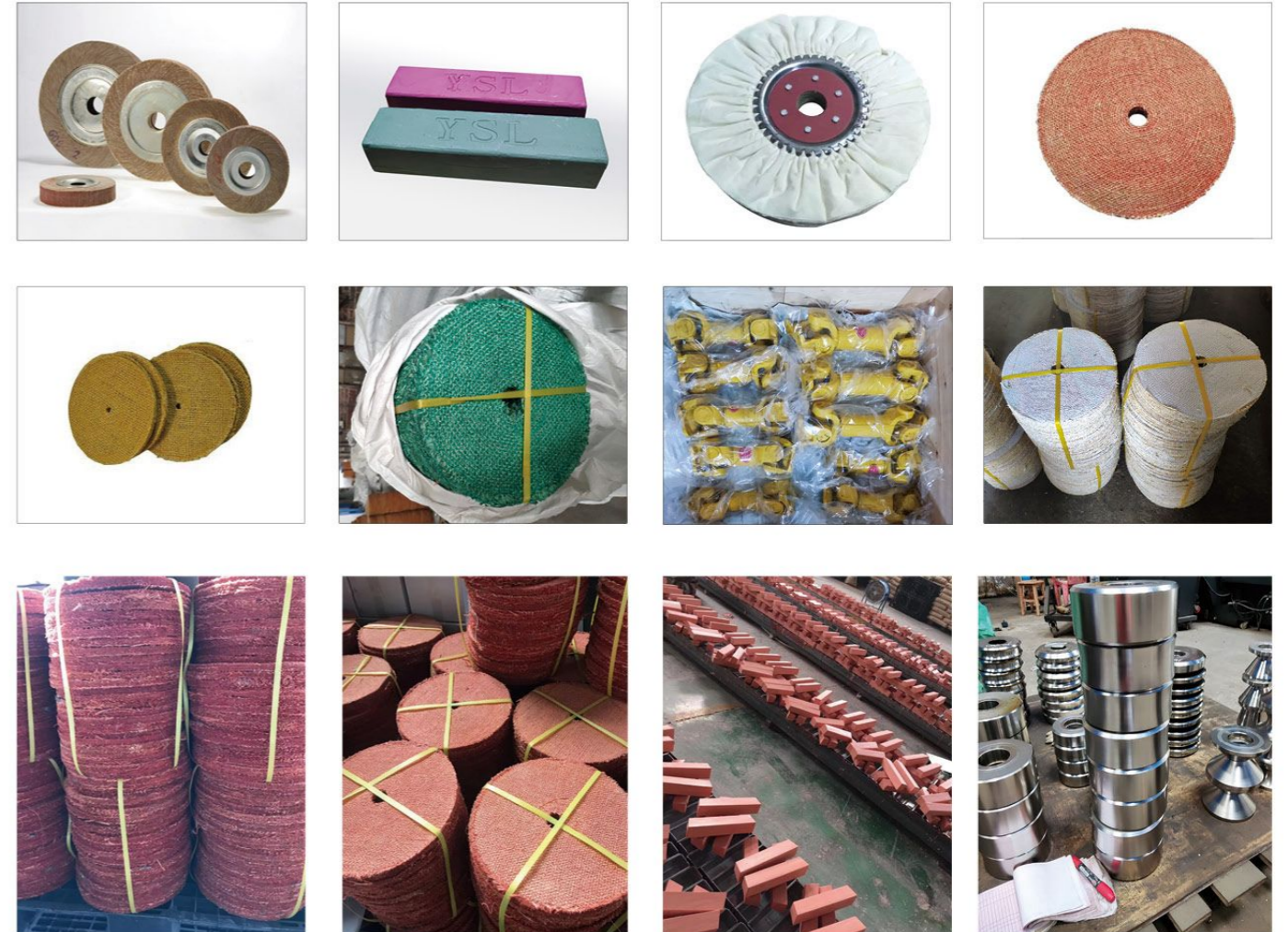

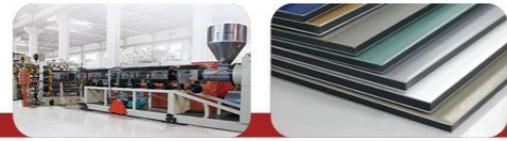

Aluminum-plastic composite panel

铝塑复合板



ACP background

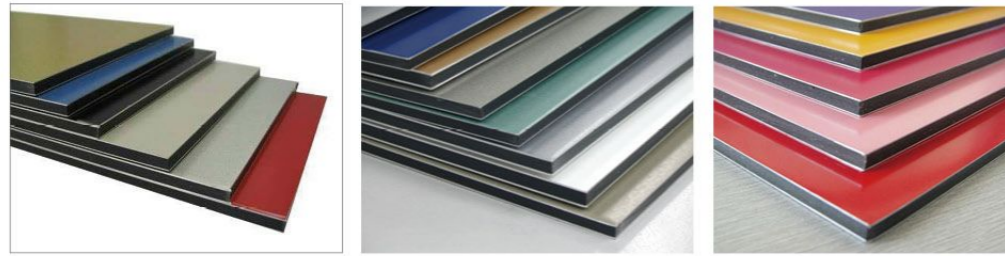

Aluminium composite panel 500x500 铝制复合板 500x500

Aluminum composite panel production line
铝复合板生产线

Professional, efficient and win-win development
专业 | 高效 | 发展 | 共赢



Aluminum-plastic composite panel

铝塑复合板

Color coated aluminium coil

铝卷



jsw colour coated coils 500x500



Fluorocarbon coated color coated aluminum coil (PVDF):
The fluorocarbon coating is a coating of PVDF resin mainly referring to a vinylidene fluoride homopolymer or a copolymer of vinylidene fluoride and other small amount of fluorine-containing vinyl monomer. The chemical structure of the fluoric acid base is combined by a fluorine/carbon bond. This chemical structural stability and firmness make the physical properties of fluorocarbon coatings different from conventional coatings. In addition to the abrasion resistance in terms of mechanical properties, impact resistance has excellent performance, especially in harsh weather and environment, showing long-lasting resistance to fading and UV. After the high temperature barbecue is formed into a film, the molecular structure in the coating is tight and has excellent weather resistance. It is especially suitable for the decoration and display of indoor, outdoor decoration, commercial chain, exhibition advertisements, etc. in public places.

Polymeric membrane adhesive film

高分子膜

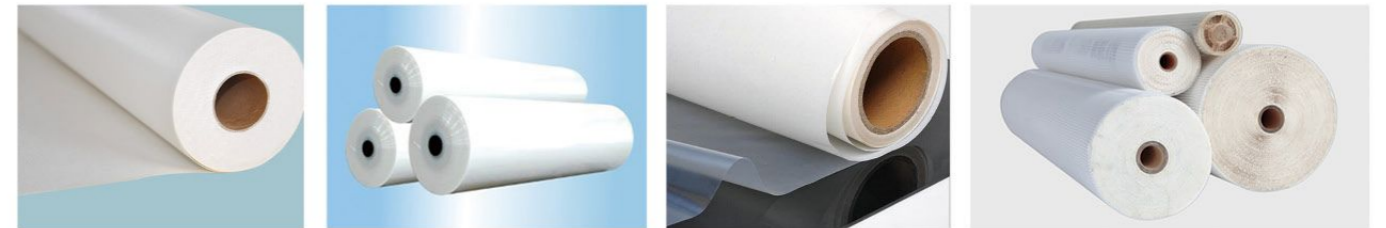

Polymeric membrane inside photos

Protective film for ACP

保护膜



ALUMINUM COMPOSITE PANEL Protective Film